

## NP6-1.2Ah

Valve-regulated lead-acid battery



# GENERAL PURPOSE SERIES

### Characteristics

Nominal voltage	6V (3 cells per unit)	
Nominal capacity at 20 hours rate/5.25V (25°C)	1.2Ah	
Capacity (25°C)	10 Hours rate/5.25V	1.1Ah
	5 Hours rate/5.25V	1.05Ah
Terminal type	T1	
Torque	N/A	
Approx. internal resistance (25°C)	52.0mΩ	
Dimensions	Length	98±1mm (3.86inch)
	Width	24±1mm (0.94inch)
	Height	52±1mm (2.05inch)
	Total height	58±1mm (2.28inch)
Design Life (stand-by)	JIS at 25°C	5 years
	Eurobat at 20°C	3-5 years
Weight	0.28kg (0.62lbs)±5%	
Nominal operating temperature	25±3°C (77°F±5)	
Operating temperature range	Discharge	-15°C~50°C (5°F~122°F)
	Charge	-10°C~50°C (14°F~122°F)
	Storage	-20°C~50°C (-4°F~122°F)
Float charging voltage at 25°C	6.80V~6.90V	
Cyclic charging voltage at 25°C	7.25V~7.50V	
Temperature compensation	Float charge	-9 mV/°C/Block
	Cycle charge	-15 mV/°C/Block
Max. charging current (A)	0.36A	
Max. discharge current for 5 seconds	18A	
Self discharge rate (25°C)	≤3%/month	
Battery container ABS UL94-HB	V-0 optional	

### Overview

NPP Power General Purpose series batteries are designed with state-of-the-art AGM (absorbent glass mat) technology, high-performance plates and electrolyte. With excellent value and characteristics, this range is suitable for all general purpose applications.

### Dimensions & Terminal Type (mm)

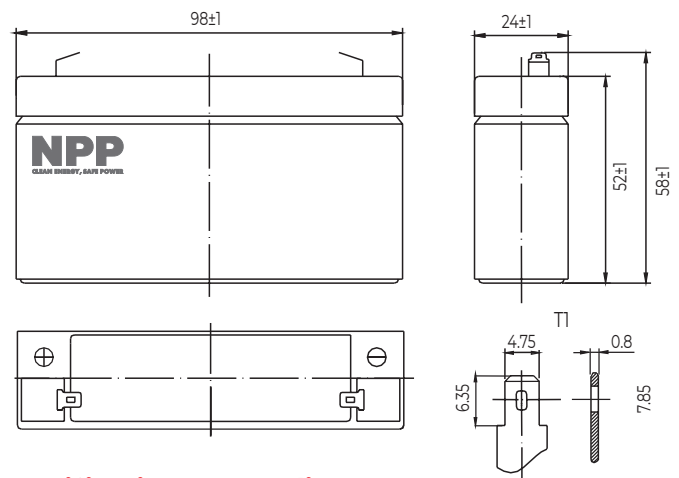

### Certification & Compliances



Compliant to: EUROBAT, RoHS, WEEE's and Reach.  
Manufactured according to IEC 60896-21 / 22

### Construction

Component	Positive Plate	Negative plate	Container	Separator	Electrolyte	Safety valve	Terminal
Raw material	Lead dioxide	Lead	ABS (V-0 opt.)	AGM	Sulfuric Acid	Rubber	Copper

### Constant current discharge characteristics at 25°C

(Ampere/battery)

F.V/Time	5min	10min	15min	30min	60min	2h	3h	4h	5h	10h	20h
4.80V	4.58	2.90	2.27	1.28	0.79	0.43	0.30	0.25	0.21	0.11	0.06
4.95V	4.45	2.82	2.21	1.25	0.77	0.43	0.30	0.24	0.21	0.11	0.06
5.10V	4.26	2.70	2.13	1.21	0.75	0.42	0.29	0.24	0.21	0.11	0.06
5.25V	4.08	2.58	2.06	1.18	0.74	0.42	0.29	0.24	0.21	0.11	0.06
5.40V	3.85	2.44	1.95	1.14	0.72	0.41	0.28	0.23	0.20	0.11	0.06

### Constant power discharge characteristics at 25°C

(Watts/battery)

F.V/Time	5min	10min	15min	30min	60min	2h	3h	4h	5h	10h	20h
4.80V	25.6	16.4	12.9	7.32	4.55	2.52	1.77	1.47	1.25	0.68	0.37
4.95V	24.8	15.9	12.6	7.18	4.48	2.50	1.76	1.46	1.24	0.68	0.36
5.10V	23.8	15.2	12.2	6.96	4.37	2.48	1.74	1.45	1.23	0.68	0.36
5.25V	22.8	14.6	11.7	6.79	4.28	2.44	1.73	1.44	1.23	0.67	0.36
5.40V	21.5	13.8	11.1	6.54	4.15	2.38	1.68	1.39	1.19	0.66	0.35

The above characteristics represent average values and can be obtained within three charge and discharge cycles. The batteries must be fully charged before testing. The data in this document is subject to change without notice and become contractual only after written confirmation. Please contact NPP Power for the latest available version.

#### NPP Power (Vietnam) Co.,Ltd

Lot A22.3, Road C4, Thanh Thanh Cong Industrial Zone,  
An Hoa Village, Trang Bang District, Tay Ninh Province,  
Vietnam

#### Guangzhou NPP Power Co, Ltd.

No.67 Lianglong Road, Huashan Town, Huadu District,  
Guangzhou, China  
Email: info@nppower.com.cn Tel. +86 20 37887 390

# NP6-1.2Ah

Valve-regulated lead-acid battery

# GENERAL PURPOSE

## SERIES

### Discharge characteristics (25°C)

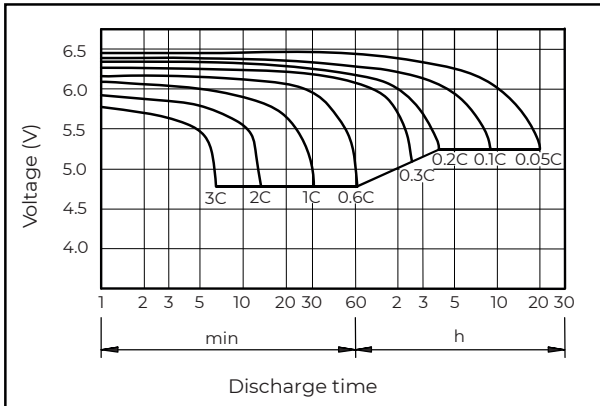

### Charging characteristics (25°C)

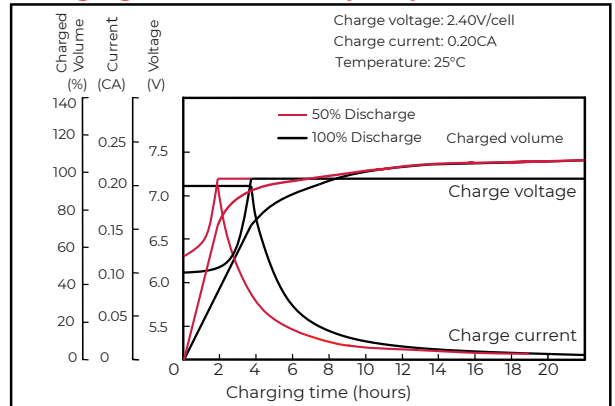

### Temperature effects on capacity

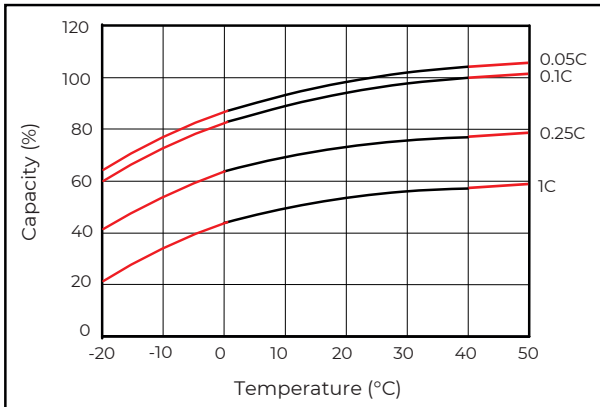

### Self-discharge characteristics

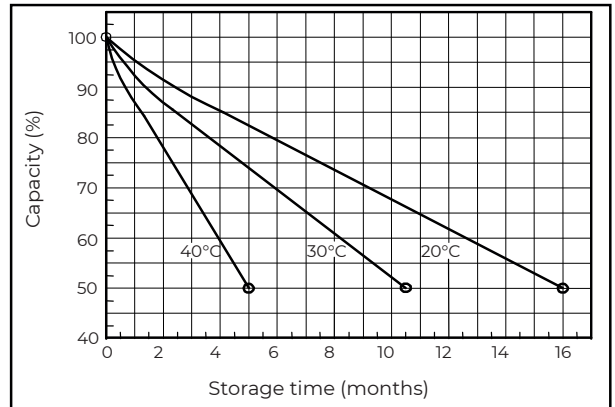

### Floating life on temperature

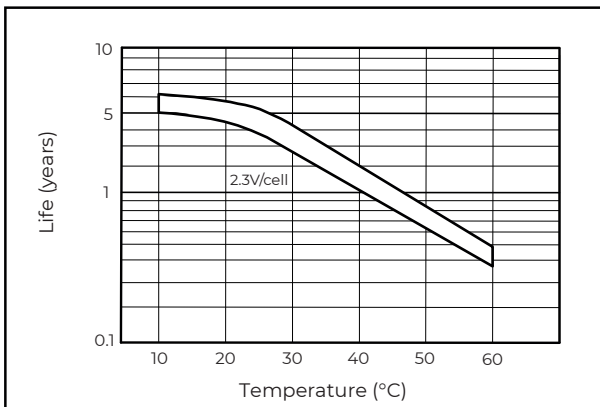

### Cycle life on D.O.D (25°C)

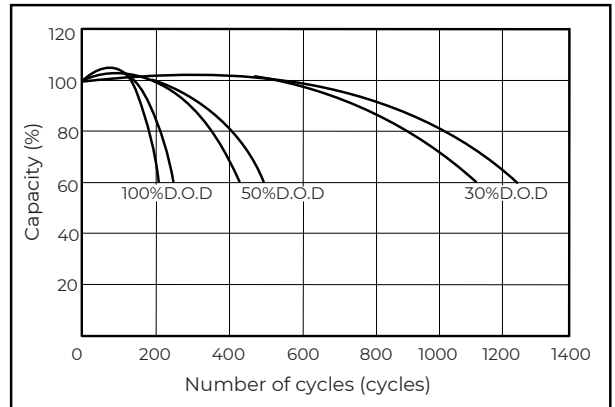

### Relationship for OCV and capacity (25°C)

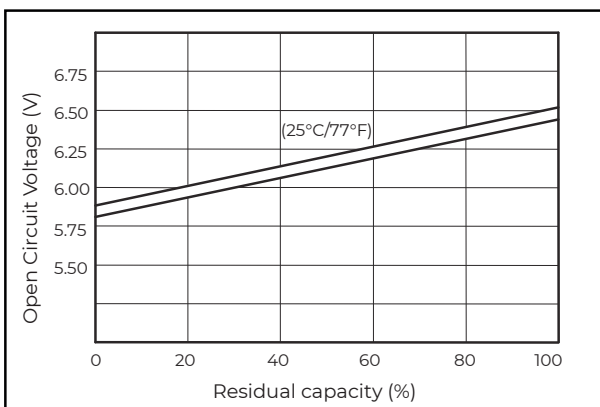

### Charging voltage VS temperature

